

# QUATTRO

## Column Formwork for moving with only one crane lift



Edition 03/2010

**PERI GmbH**  
**Formwork Scaffolding Engineering**

P.O. Box 1264

89259 Weissenhorn

Germany

Tel +49 (0)7309.950-0

Fax +49 (0)7309.951-0

info@peri.com

www.peri.com

**Important Notes:**

Without exception, all current safety regulations must be observed in those countries where our products are used.

The illustrations in this brochure are photographs of real site situations. Safety or formwork anchor details are therefore not to be taken as a definitive guide to the way the equipment is to be used.

Safety instructions and load specifications are to be strictly observed at all times. Separate structural calculations are required for any deviations from the standard design data.

The information contained herein is subject to technical changes in the interests of progress. Errors and typographical mistakes reserved.

# Content

## **PERI QUATTRO**

- 2 Fast column formwork
- 4 The user-friendly column formwork
- 6 Safe working in any height
- 8 Components
- 16 PERI International

# PERI QUATTRO

## Fast column formwork

**PERI QUATTRO can be moved as a complete unit of four connected column frames.**

For contractors, this means enormous time-savings when using the crane because the complete column with push-pull props and concreting platform is moved in only one crane lift.

**Good fairface quality\*** is achieved by screwing high-quality 21 mm Finply formlining from behind. This results in concrete surfaces without any unsightly nail or screw indentations. \*with new plywood and without high extensions.

**Permissible fresh concrete pressure** of 80 kN/m<sup>2</sup> allows concreting at high rates expected for columns.

**Efficient transportation** made possible by folding column frames.

**Column cross-sections** square or rectangular from 200 x 200 mm to 600 x 600 mm, in 50 mm increments.

QUATTRO, for moving with only one crane lift.

With only a 120 mm stacking height, PERI QUATTRO can be stacked to save space.

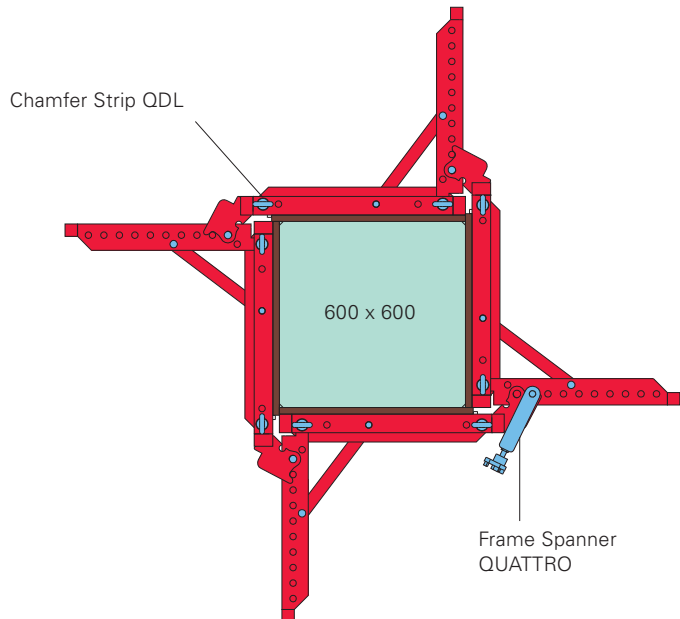
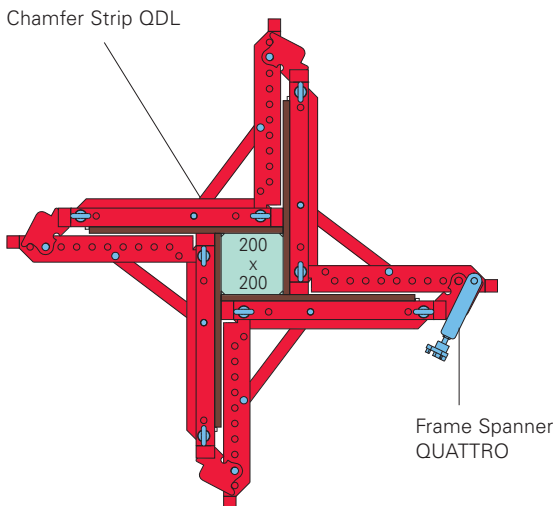
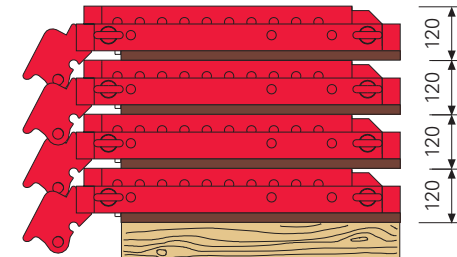

**Hight extensions in 250 mm increments**

enables an optimum high adaption. Numerous combinations are achieved by connecting just three different element heights (0.50, 1.25 and 2.75 m) with the eye bolt provided, which double as lifting points.

4.00 m high QUATTRO column. Extended with 2.75 m and 1.25 m elements. Maintaining the permissible fresh concrete pressure of 80 kN/m<sup>2</sup>.

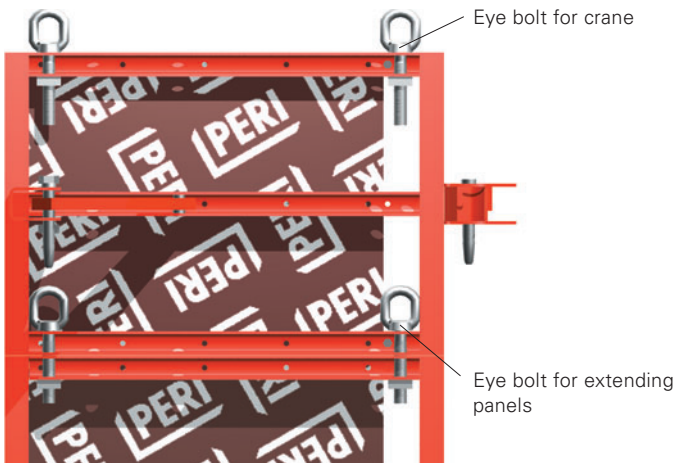

The panels are connected with eye bolts (also for crane).

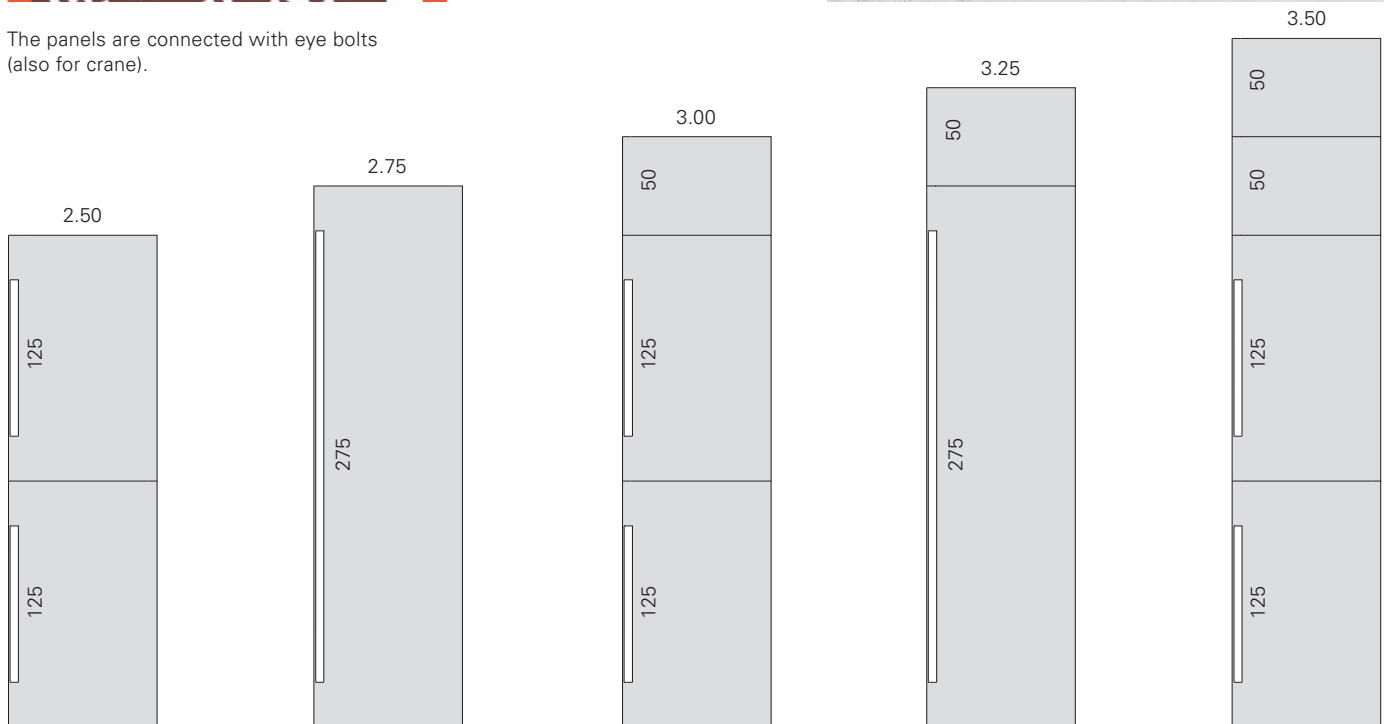

# PERI QUATTRO

## The user-friendly column formwork

4.00 m high QUATTRO column formwork for the new Lufthansa Flight Training Centre.



Moving complete units with push-pull props, concreting platform and ladder access for the residential project of Main Terrace in Frankfurt.

With the Transportation Wheel QUATTRO (4 per column), the complete unit can be moved manually.

**Time-savings with every use**

QUATTRO has no loose parts to get lost in the course of erection and striking. The formwork is tightened or separated with only a few simple movements.

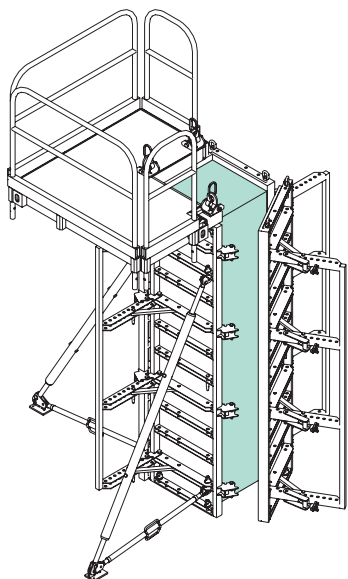

**1.** Slacken off frame spanner and open first column frame.

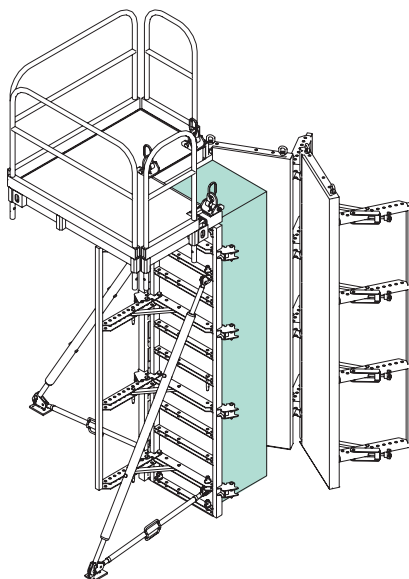

**2.** Release second frame from concrete. Use additional pins to hold both frames open in this position (see detail).

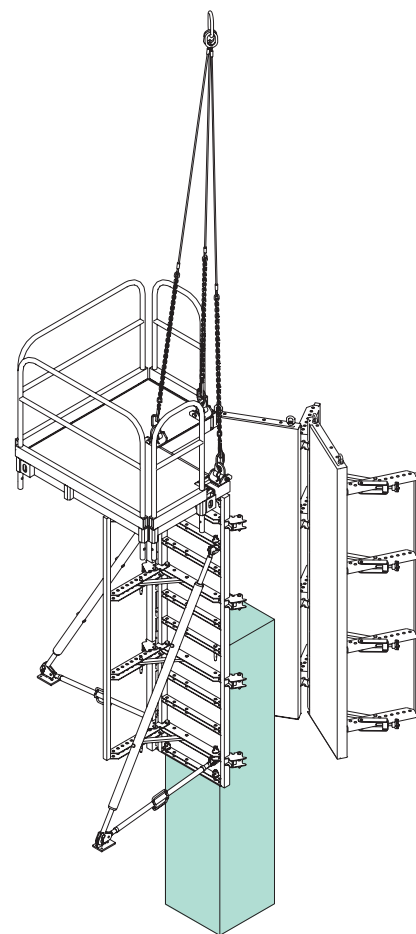

**3.** Suspend formwork from crane and shift to next point of use.

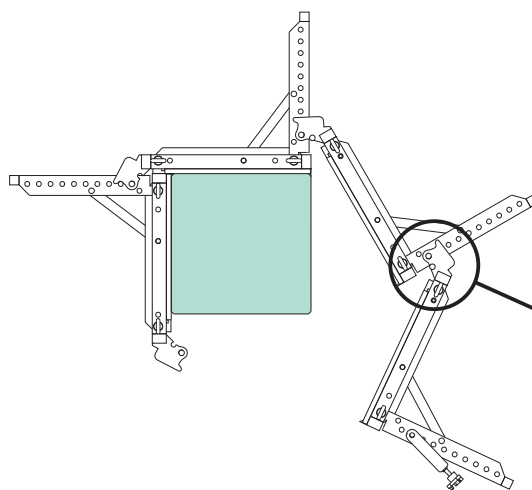
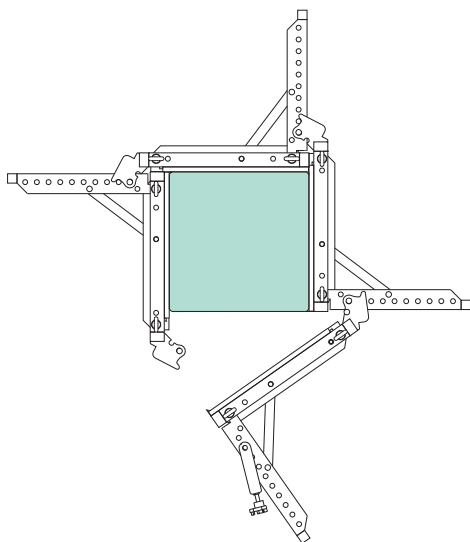

**Detail**

Pin  $\varnothing$  20 x 140

# Safe working in any height

## Ladder access and concreting platform

### PERI QUATTRO Ladders and concreting platform - for your safety

- The PERI concreting platform is delivered to site ready for use. No loose parts to get lost, no laborious fitting of separate platform brackets, scaffold boards, handrail boards etc. No longer has support structure underneath to get in the way.
- The concreting platform fits any cross-section from 200 x 200 mm to 600 x 600 mm.
- The lightweight aluminium platform is easily mounted on QUATTRO column form by hand.
- The connections of the PERI concreting platform also serve as the crane hooks.



Ladders for safe access of the platforms.

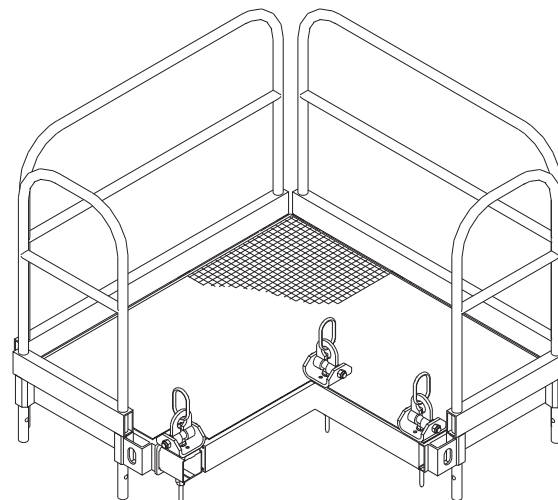

PERI Concreting Platform, complete, Item-no.: 037400.

The concreting platform for a load of 150 kg/m<sup>2</sup>.

Safe concreting at any height with PERI concreting platform.



**Access ladders for PERI QUATTRO column formwork**

Ladder Safety Cage 150, Item-no.: 051450  
 Ladder Safety Cage 75, Item-no.: 104132

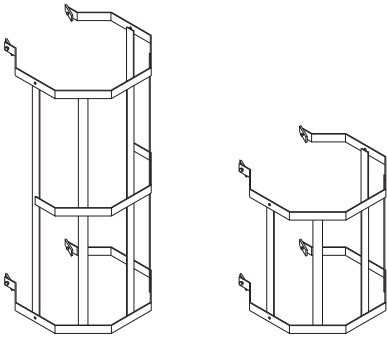

Ladder 180/6, Item. -no.: 051410  
 Access Ladder 180/2, Item-no.: 103724

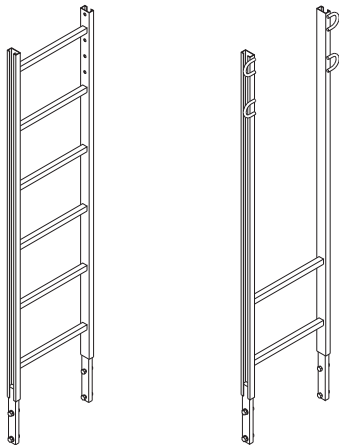

Ladder Connector QUATTRO, Item-no.: 103391

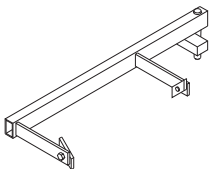

Ladder Hook, Item-no.: 103718  
 Ladder Base, Item-no.: 051460



Item no.	Weight kg
109926	206,000

## QUATTRO Frame QES 350

Column panel with 20 mm plywood, screwed on from the rear. For cross-sections in 5 cm increments from 20 x 20 cm to 60 x 60 cm. Eye bolt as load-bearing point and for extensions. Without chamfer strip.

## Complete with

- 2 pc. 724812 Stair Tower Eye Bolt M20 x 110, galv.
- 2 pc. 710045 Nut DIN 557-4 M20, galv.
- 13 pc. 105400 Bolt Ø 20 x 140, galv.
- 13 pc. 018060 Cotter Pin 4/1, galv.
- 1 pc. 037550 Base Plate QUATTRO QB

## Safety Instructions

Load-bearing point capacity 1.0 t.

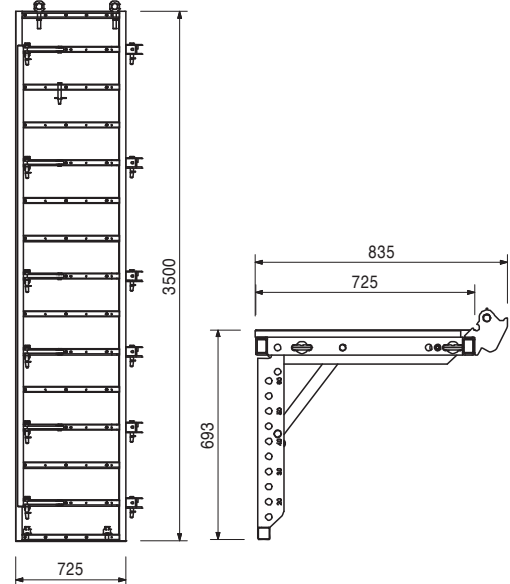
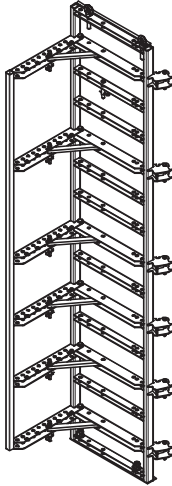

109925	158,000
--------	---------

## QUATTRO Frame QES 275

Column panel with 20 mm plywood, screwed on from the rear. For cross-sections in 5 cm increments from 20 x 20 cm to 60 x 60 cm. Eye bolt as load-bearing point and for extensions. Without chamfer strip.

## Complete with

- 2 pc. 724812 Stair Tower Eye Bolt M20 x 110, galv.
- 2 pc. 710045 Nut DIN 557-4 M20, galv.
- 9 pc. 105400 Bolt Ø 20 x 140, galv.
- 9 pc. 018060 Cotter Pin 4/1, galv.
- 1 pc. 037550 Base Plate QUATTRO QB

## Safety Instructions

Load-bearing point capacity 1.0 t.

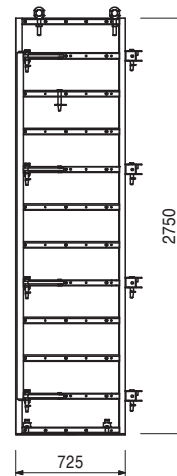
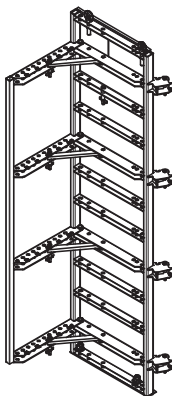

Item no.	Weight kg
109924	73,800

### QUATTRO Frame QES 125

Column panel with 20 mm plywood, screwed on from the rear. For cross-sections in 5 cm increments from 20 x 20 cm to 60 x 60 cm. Eye bolt as load-bearing point and for extensions. Without chamfer strip.

### Complete with

- 2 pc. 724812 Stair Tower Eye Bolt M20 x 110, galv.
- 2 pc. 710045 Nut DIN 557-4 M20, galv.
- 5 pc. 105400 Bolt Ø 20 x 140, galv.
- 5 pc. 018060 Cotter Pin 4/1, galv.

### Safety Instructions

Load-bearing point capacity 1.0 t.

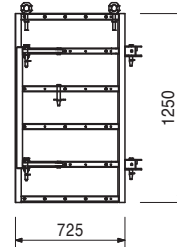
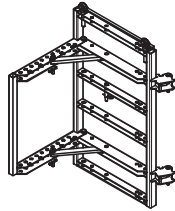

109923	32,300
--------	--------

### QUATTRO Frame QES 50

Column panel with 20 mm plywood, screwed on from the rear. For cross-sections in 5 cm increments from 20 x 20 cm to 60 x 60 cm. Eye bolt as load-bearing point and for extensions. Without chamfer strip.

### Complete with

- 2 pc. 724812 Stair Tower Eye Bolt M20 x 110, galv.
- 2 pc. 710045 Nut DIN 557-4 M20, galv.
- 2 pc. 105400 Bolt Ø 20 x 140, galv.
- 2 pc. 018060 Cotter Pin 4/1, galv.

### Safety Instructions

Load-bearing point capacity 1.0 t.

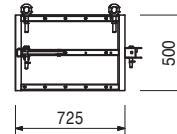
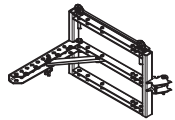

105448	0,665
037610	0,520
037600	0,230
037590	0,100

### Chamfer Strips QDL

#### Chamfer Strip QDL 350

#### Chamfer Strip QDL 275

#### Chamfer Strip QDL 125

#### Chamfer Strip QDL 50

Plastic chamfer strip with nailing panel. Edge length 15 x 15 mm.

### L

3500

2750

1250

500

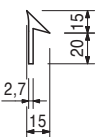
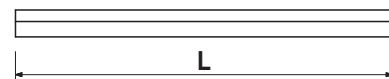
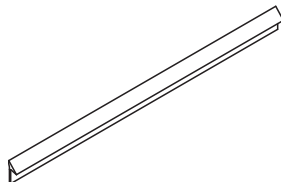

037550	3,240
--------	-------

### Base Plate QUATTRO QB

For protecting the plywood formlining against damage.

### Complete with

- 2 pc. 030130 Cam Nut DW 15, galv.

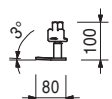
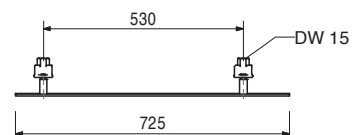
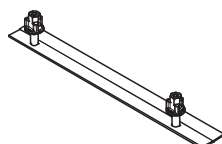

Item no.	Weight kg
037540	2,370

### Frame Spanner QUATTRO QA

For bracing QUATTRO column elements. Only required on a column corner.

### Note

Required no. of pieces:  
 h = 3.50 m 6 pieces, h = 2.75 m 4 pieces  
 h = 1.25 m 2 pieces, h = 0.50 m 1 piece

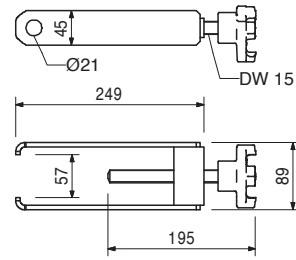
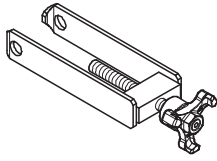

037530	1,140
--------	-------

### Brace Connector QUATTRO QR

For connecting push-pull props and kickers to QUATTRO and LICO panels.

### Complete with

1 pc. 027170 Bolt Ø 16 x 42, galv.  
 1 pc. 018060 Cotter Pin 4/1, galv.

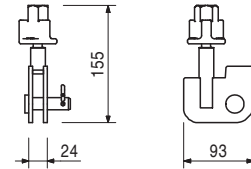
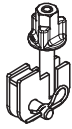

724500	0,098
--------	-------

### Bolt Ø 20 x 42, QUATTRO, galv.

For different connections.

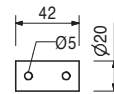

Accessories

018060	0,030
--------	-------

### Cotter Pin 4/1, galv.

105400	0,330
--------	-------

### Bolt Ø 20 x 140, galv.

For different connections.

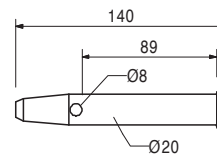
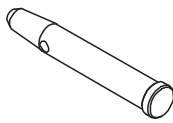

Accessories

018060	0,030
--------	-------

### Cotter Pin 4/1, galv.

018060	0,030
--------	-------

### Cotter Pin 4/1, galv.

For pins up to Ø 25 mm.



# QUATTRO Column Formwork

Item no.	Weight kg
105791	16,900

## Transportation Wheel QUATTRO

For moving completely assembled QUATTRO column formwork. Always use 4 pieces per column.

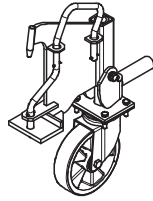

## Technical Data

Bearing capacity 500 kg.

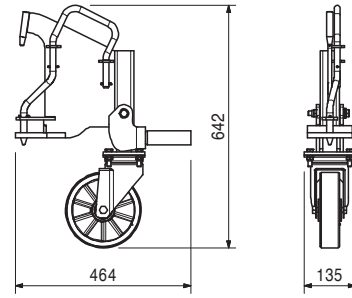

037400	123,000
--------	---------

## Concreting Platform, compl.

Working and concreting platform for TRIO, RAPID and QUATTRO Column Formwork.

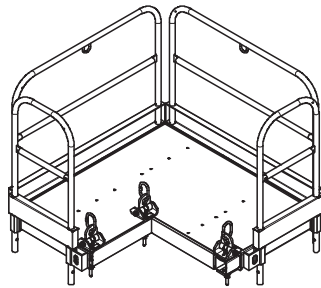

## Complete with

- 1 pc. 037410 Concreting Landing, Alu
- 2 pc. 037420 Platform Guardrail 52, galv.
- 2 pc. 037430 Platform Guardrail 134, galv.
- 3 pc. 037440 Crane Hook Concreting Platform

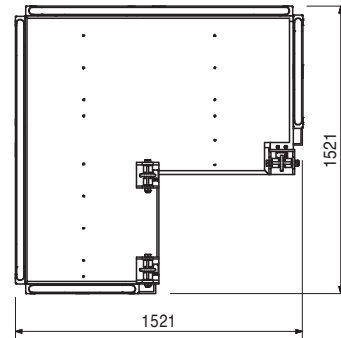

037410	51,400
--------	--------

## Concreting Landing, Alu

Continuously adjusts to all column cross-sections up to max. 60 x 60 cm. Attachment is carried out using the crane eye of the concreting platform.

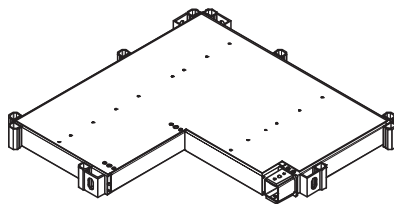

## Technical Data

Permissible load 150 kg/m<sup>2</sup>.

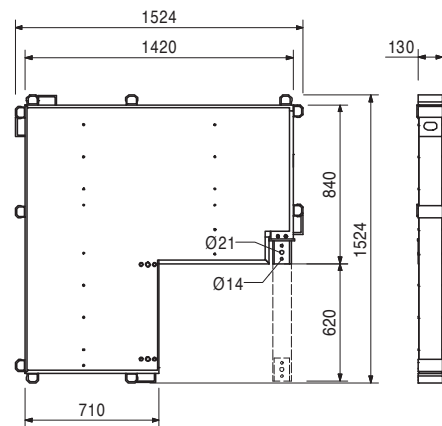

# QUATTRO Column Formwork



Item no.	Weight kg
037420	10,200

## Platform Guardrail 52, galv.

As guardrails for PERI concreting platforms. Locks in place automatically.

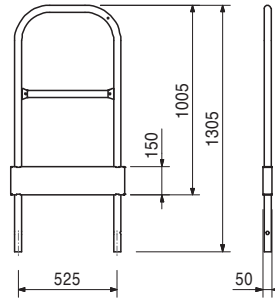
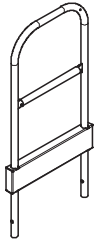

037430	17,100
--------	--------

## Platform Guardrail 134, galv.

As guardrails for PERI concreting platforms. Locks in place automatically.

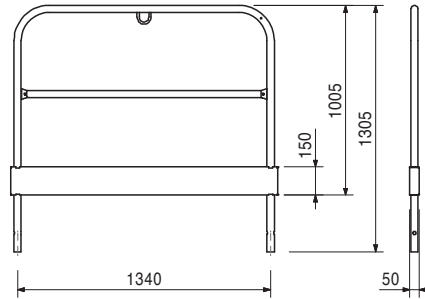
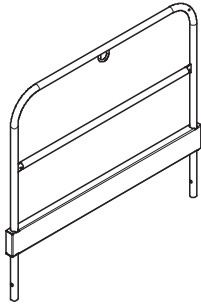

115352	15,100
--------	--------

## Platform Front Guardrail 86/86

As guardrail for PERI concreting platforms towards the column. Mounted with Screw-on Coupler.

**Note**  
Wrench size SW 19.

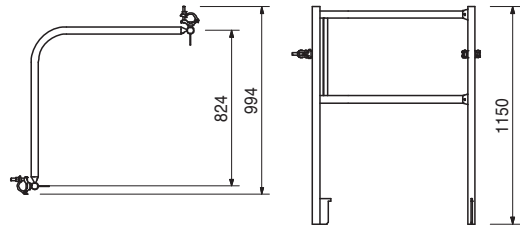
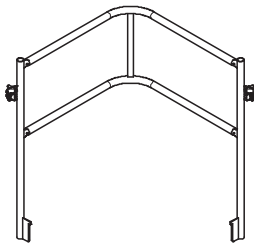

037440	5,700
--------	-------

## Crane Hook Concreting Platform

For assembling the concreting landing on the RAPID and QUATTRO column frames.

## Safety Instructions

Load-bearing point: capacity 1.0 t.

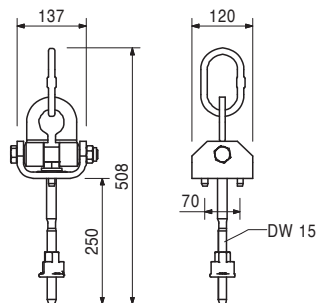
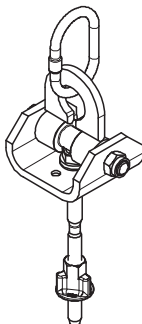

# QUATTRO Column Formwork



Item no.	Weight kg
051410	11,700

**Ladder 180/6, galv.**  
As access for PERI formwork systems.

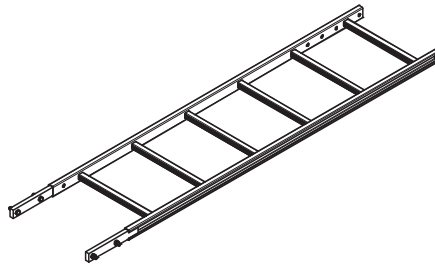

**Complete with**  
4 pc. 710224 Bolt ISO 4017 M12 x 40-8.8, galv.  
4 pc. 710381 Nut ISO 7042 M12-8, galv.

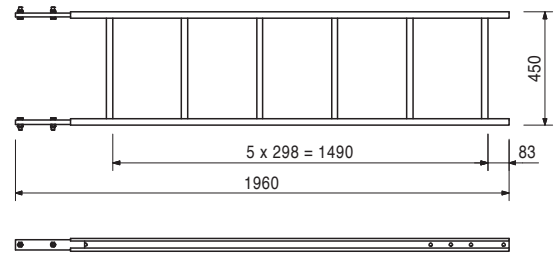

103724	10,400
--------	--------

**End Ladder 180/2, galv.**  
As access for PERI formwork systems.

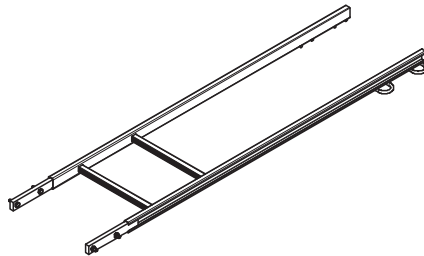

**Complete with**  
4 pc. 710224 Bolt ISO 4017 M12 x 40-8.8, galv.  
4 pc. 710381 Nut ISO 7042 M12-8, galv.

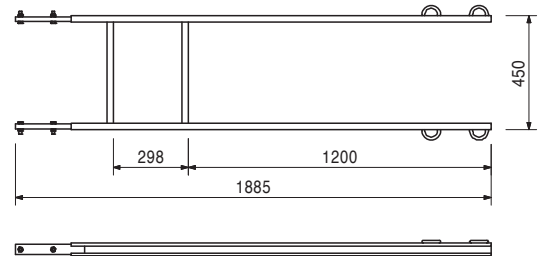

051460	2,180
--------	-------

**Ladder Base, galv.**  
As bottom ladder connection and for securing ladders against sliding on the scaffold decks.

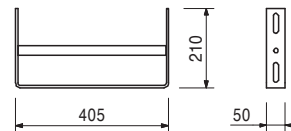
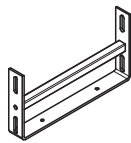

103718	0,684
--------	-------

**Ladder Hook, galv.**  
For adjusting the bottom ladder.  
Always use in pairs.



**Complete with**  
2 pc. 710266 Bolt ISO 4017 M12 x 25-8.8, galv.  
2 pc. 710381 Nut ISO 7042 M12-8, galv.

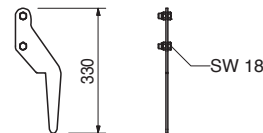

Item no.	Weight kg
103391	4,890

### Ladder Connector QUATTRO

For connecting ladders to QUATTRO column panels.

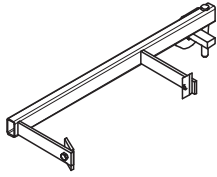

### Complete with

2 pc. 701763 Clamping Plate FI 25 x 10 x 90  
2 pc. 710266 Bolt ISO 4017 M12 x 25-8.8, galv.

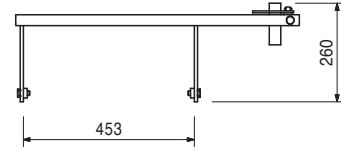
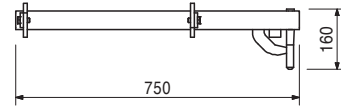

104132	15,600
051450	25,200

### Ladder Safety Cages

#### Ladder Safety Cage 75, galv.

#### Ladder Safety Cage 150, galv.

Ladder safety cage for PERI access ladders.

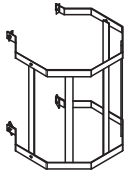

### Complete with

4 pc. 710266 Bolt ISO 4017 M12 x 25-8.8, galv.

4 pc. 701763 Clamping Plate FI 25 x 10 x 90

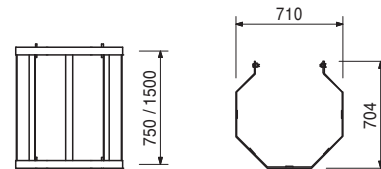

028010	17,800
--------	--------

### Push-Pull Prop RSS I

Extension length L = 2.05 - 2.94 m.

For aligning PERI formwork systems.

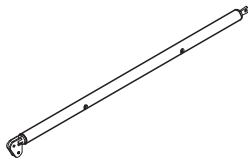

### Note

Permissible load: see PERI Design Tables.

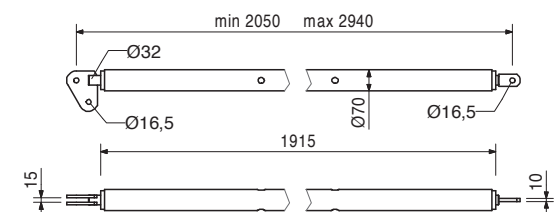

028020	21,900
--------	--------

### Push-Pull Prop RSS II

Extension length L = 2.91 - 3.80 m.

For aligning PERI formwork systems.

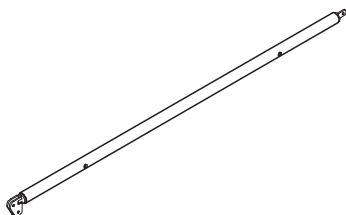

### Note

Permissible load: see PERI Design Tables.

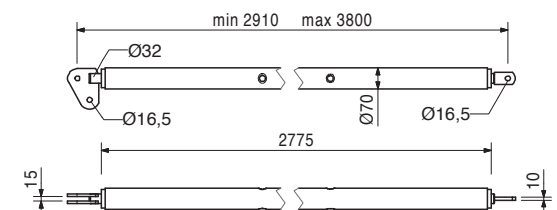



# QUATTRO Column Formwork



Item no.	Weight kg
028110	5,180

### Kicker AV

Extension length L = 1.08 - 1.40 m.  
For aligning PERI formwork systems.

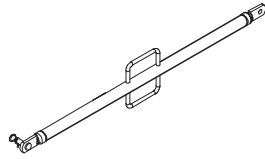

### Complete with

1 pc. 027170 Bolt Ø 16 x 42, galv.  
1 pc. 018060 Cotter Pin 4/1, galv.

### Note

Permissible load: see PERI Design Tables.

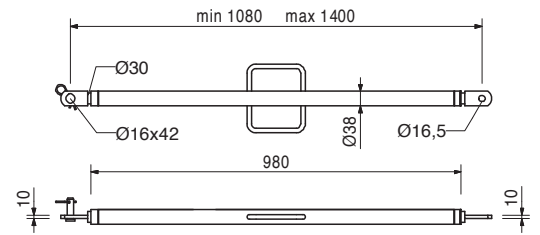

108135	13,000
--------	--------

### Kicker AV 210

Extension length L = 1.28 - 2.10 m.  
For aligning PERI formwork systems.

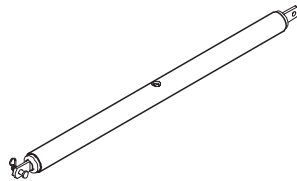

### Complete with

1 pc. 027170 Bolt Ø 16 x 42, galv.  
1 pc. 018060 Cotter Pin 4/1, galv.

### Note

Permissible load: see PERI Design Tables.

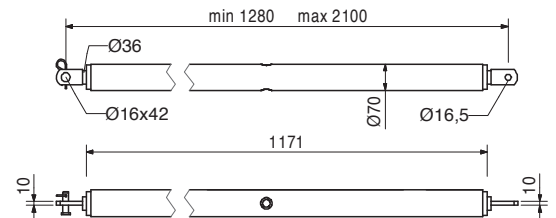

106000	1,820
--------	-------

### Base Plate-2 for RSS, galv.

For assembly of RSS push-pull props.

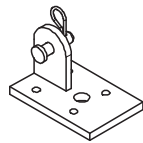

### Complete with

1 pc. 027170 Bolt Ø 16 x 42, galv.  
1 pc. 018060 Cotter Pin 4/1, galv.

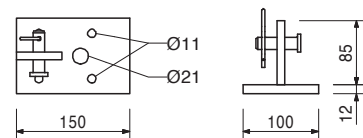



**01 PERI GmbH**  
 Rudolf-Diesel-Strasse  
 89264 Weissenhorn  
 info@peri.com  
 www.peri.com



**02 France**  
 PERI S.A.S.  
 77109 Meaux Cedex  
 peri.sas@peri.fr  
 www.peri.fr

**03 Switzerland**  
 PERI AG  
 8472 Ohringen  
 info@peri.ch  
 www.peri.ch

**04 Spain**  
 PERI S.A.  
 28110 Algete - Madrid  
 info@peri.es  
 www.peri.es

**05 Belgium/Luxembourg**  
 N.V. PERI S.A.  
 1840 Londerzeel  
 info@peri.be  
 www.peri.be

**06 Netherlands**  
 PERI B.V.  
 5480 AH-Schijndel  
 info@peri.nl  
 www.peri.nl

**07 USA**  
 PERI Formwork Systems, Inc.  
 Elkridge, MD 21075  
 info@peri-usa.com  
 www.peri-usa.com

**08 Indonesia**  
 PT Beton Perkasa Wijaksana  
 Jakarta 10210  
 bpw@betonperkasa.com  
 www.peri.com

**09 Italy**  
 PERI S.p.A.  
 20060 Basiano  
 info@peri.it  
 www.peri.it

**10 Japan**  
 PERI Japan K.K.  
 Tokyo 103-0015  
 info@perijapan.jp  
 www.perijapan.jp

**11 United Kingdom/Ireland**  
 PERI Ltd.  
 Rugby, CV23 0AN  
 info@peri.ltd.uk  
 www.peri.ltd.uk

**12 Turkey**  
 PERI Kalıp ve İskeleleri  
 Esenyurt / İstanbul 34510  
 info@peri.com.tr  
 www.peri.com.tr

**13 Hungary**  
 PERI Kft.  
 1181 Budapest  
 info@peri.hu  
 www.peri.hu

**14 Malaysia**  
 PERI Formwork Malaysia  
 Sdn. Bhd.  
 43300 Seri Kembangan,  
 Selangor Darul Ehsan  
 info@perimalaysia.com  
 www.perimalaysia.com

**15 Singapore**  
 PERI ASIA Pte. Ltd  
 Singapore 387355  
 pha@periasia.com  
 www.periasia.com

**16 Austria**  
 PERI Ges.mbh  
 3134 Nußdorf ob der Traisen  
 office@peri.at  
 www.peri.at

**17 Czech Republic**  
 PERI spol. s r.o.  
 252 42 Jesenice u Prahy  
 info@peri.cz  
 www.peri.cz

**18 Denmark**  
 PERI Danmark A/S  
 2670 Greve  
 peri@peri.dk  
 www.peri.dk

**19 Finland**  
 PERI Suomi Ltd. Oy  
 05460 Hyvinkää  
 info@perisuomi.fi  
 www.perisuomi.fi

**20 Norway**  
 PERI NORGE AS  
 3036 Drammen  
 info@peri.no  
 www.peri.no

**21 Poland**  
 PERI Polska Sp. z o.o.  
 05-860 Płochocin  
 info@peri.pl.pl  
 www.peri.pl.pl

**22 Sweden**  
 PERIform Sverige AB  
 30013 Halmstad  
 peri@periform.se  
 www.periform.se

**23 Korea**  
 PERI (Korea) Ltd.  
 Seoul 135-080  
 info@perikorea.com  
 www.perikorea.com

**24 Portugal**  
 PERIcofragens Lda.  
 2790-326 Queijas  
 info@peri.pt  
 www.peri.pt

**25 Argentina**  
 PERI S.A.  
 B1625GPA Escobar  
 Prov. Bs. As.  
 info@peri.com.ar  
 www.peri.com.ar

**26 Brazil**  
 PERI Formas e  
 Escoramentos Ltda.  
 CEP 06730-000  
 Vargem Grande Paulista  
 São Paulo  
 info@peribrasil.com.br  
 www.peribrasil.com.br

**27 Chile**  
 PERI Chile Ltda.  
 Colina, Santiago de Chile  
 peri.chile@peri.cl  
 www.peri.cl

**28 Romania**  
 PERI România SRL  
 077015 Balotești - ILFOV  
 info@peri.ro  
 www.peri.ro

**29 Slovenia**  
 PERI Slowenien  
 Goran Opalic  
 2000 Maribor  
 peri.slo@triera.net  
 www.peri.com

**30 Slovakia**  
 PERI spol. s r.o.  
 903 01 Senec  
 info@peri.sk  
 www.peri.sk

**31 Australia**  
 PERI Australia Pty. Ltd.  
 Glendenning NSW 2761  
 info@periaus.com.au  
 www.periaus.com.au

**32 Estonia**  
 PERI AS  
 76406 Saku vald  
 Harjumaa  
 peri@peri.ee  
 www.peri.ee

**33 Greece**  
 PERI Hellas Ltd.  
 194 00 Koropi  
 info@perihellas.gr  
 www.perihellas.gr

**34 Latvia**  
 PERI SIA  
 2118 Salaspils novads,  
 Rigas rajons  
 info@peri-latvija.lv  
 www.peri-latvija.lv

**35 United Arab Emirates**  
 PERI (L.L.C.)  
 Dubai  
 perillc@perime.com  
 www.perime.com



**36 Canada**  
PERI Formwork Systems, Inc.  
Bolton, Ontario  
L7E 1K1  
info@peri.ca  
www.peri.ca

**37 Lebanon**  
Lebanon Representative Office  
Jdeideh  
lebanon@peri.de  
www.peri.de

**38 Lithuania**  
PERI UAB  
02300 Vilnius  
info@peri.lt  
www.peri.lt

**39 Morocco**  
PERI S.A.  
Tanger  
peri25@menara.ma  
www.peri.com

**40 Israel**  
PERI Formwork  
Engineering Ltd  
Petach Tikva, 49002  
info@peri.co.il  
www.peri.co.il

**41 Bulgaria**  
PERI BULGARIA EOOD  
1839 Sofia  
peri.bulgaria@peri.bg  
www.peri.bg

**42 Iceland**  
Armar ehf.  
220 Hafnarfjörður  
www.armor.is

**43 Kazakhstan**  
TOO PERI Kazakhstan  
050010 Almaty  
peri@peri.kz  
www.peri.kz

**44 Russian Federation**  
OOO PERI  
142403 Noginsk  
moscow@peri.ru  
www.peri.ru

**45 South Africa**  
Wiehahn Formwork and  
Scaffolding (Pty) Ltd.  
7600 Stellenbosch  
info@wiehahn.co.za  
www.wiehahn.co.za

**46 Ukraine**  
TOW PERI Ukraina  
07400 Brovary  
peri@peri.ua  
www.peri.ua

**47 Egypt**  
Egypt Branch Office  
11361 Heliopolis / Cairo  
info@peri.com.eg  
www.peri.com.eg

**48 Serbia**  
PERI Oplate d.o.o.  
11272 Dobanovci  
office@peri.co.yu  
www.peri.co.yu

**49 Mexico**  
PERI Cimbras y Andamios,  
S.A. de C.V.  
Estado de México,  
C.P. 54680  
info@peri.com.mx  
www.peri.com.mx

**50 Azerbaijan**  
PERI Kalıp ve İskeleleri  
Baku  
peribaku@peri.com.tr  
www.peri.com.tr

**51 Turkmenistan**  
PERI Kalıp ve İskeleleri  
Aşgabat  
ahmet.kadioglu@peri.com.tr  
www.peri.com.tr

**52 Belorussia**  
PERI Belarus  
220030 Minsk  
peri@mail.belpak.by  
www.peri.com

**53 Croatia**  
PERI oplate i skele d.o.o.  
10 250 Donji Stupnik/  
Zagreb  
info@peri.com.hr  
www.peri.com.hr

**54 Iran**  
PERI GmbH  
Iran Branch Office  
Tehran-Iran  
info@peri.ir  
www.peri.ir

**55 India**  
PERI (India) Pvt Ltd  
Mumbai – 400064  
info@peri.in  
www.peri.in

**56 Jordan**  
PERI GmbH - Jordan  
11947 Amman  
jordan@peri.com  
www.peri.com

**57 Kuwait**  
PERI Kuwait  
13011 Kuwait  
kuwait@peri.com  
www.peri.com

**58 Saudi Arabia**  
PERI Saudi Arabia  
Jeddah - 21463  
K.S.A  
info@peri.com.sa  
www.peri.com.sa

**59 Qatar**  
PERI Qatar LLC  
Doha  
info@periqatar.com  
www.periqatar.com

**60 Algeria**  
Société PERI S.A.S.  
Kouba - Alger  
peri.alger@peri.fr  
www.peri.fr

**61 Albania**  
Tirane  
erti.hasanaj@peri.com.tr  
www.peri.com.tr

**62 Peru**  
PERI Peruana SAC  
Chorrillos, Lima  
contacto@peri.com.pe  
www.peri.com.pe

**63 Panama**  
PERI Panama Inc.  
587 Panama City  
johnny.fernandezc@peri.com.pa  
www.peri.com.pa

**64 Angola**  
PERIcofragens, Lda.  
Luanda  
renato.portugal@peri.pt  
www.peri.pt

**65 Nigeria**  
Heights Access Nigeria Ltd.  
Victoria Island, Lagos

**66 Oman**  
PERI (L.L.C.)  
Muscat  
Sultanate of Oman  
perimct@perime.com  
www.perime.com

# PERI Product Range



## Wall Formwork

Panel Formwork  
Girder Formwork  
Circular Formwork  
Facade Formwork  
Brace Frame



## Climbing Systems

Climbing Scaffold  
Self-Climbing System  
Climbing Protection Panel  
Platform Systems



## Column Formwork

Square  
Rectangular  
Circular



## Scaffold, Stairways, Working Platforms

Facade Scaffold  
Working Platform  
Weather Protection Roof  
Stairway Access



## Slab Formwork

Panel Formwork  
Beam Grid Formwork  
Girder Formwork  
Slab Table  
Beam Formwork



## Bridge and Tunnel Formwork

Cantilevered Parapet Carriage  
Cantilevered Parapet Platform  
Engineer's Construction Kit



## Shoring Systems

Steel Slab Props  
Aluminium Slab Props  
Tower Systems  
Heavy-Duty Props



## Services

Formwork Assembly  
Cleaning / Repairs  
Formwork Planning  
Software  
Statics  
Special Constructions

Additional Systems  
Plywood  
Formwork Girders  
Stopend Systems  
Pallets  
Transportation Containers



## PERI GmbH Formwork Scaffolding Engineering

P.O. Box 1264  
89259 Weissenhorn  
Germany  
Tel +49 (0)73 09.9 50-0  
Fax +49 (0)73 09.9 51-0  
info@peri.com  
www.peri.com